

Medium Pressure Filter Pi 3000

Nominal pressure 200/315 bar (2900/4570 psi), nominal size up to 400
according to DIN 24550

1. Features

High performance filters for modern hydraulic systems

- Provided for pipe installation
- Modular system
- Compact design
- Minimal pressure drop through optimal flow design
- Visual/electrical/electronic maintenance indicator
- Threaded connections
- Quality filters, easy to service
- Equipped with highly efficient glass fibre PS filter elements
- Beta rated elements according to ISO 16889
- Elements with high differential pressure stability and dirt holding capacity
- NPT- and SAE-connections on request
- Worldwide distribution



2. Flow rate/pressure drop curve (filter housing incl. element)

190 mm²/s
33 mm²/s

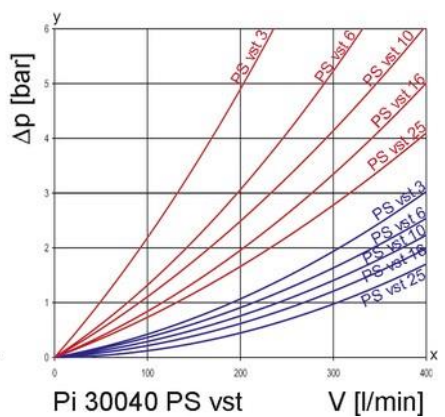
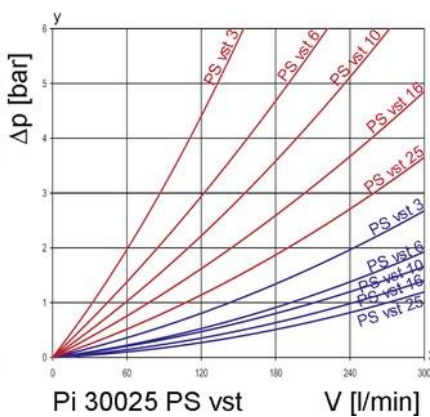
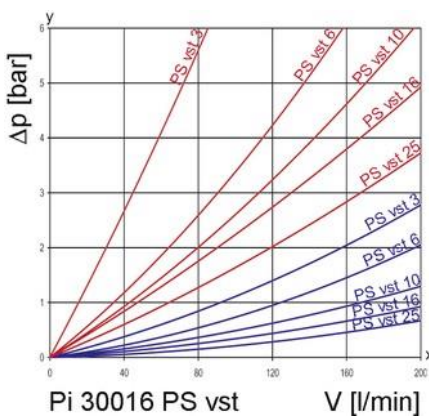
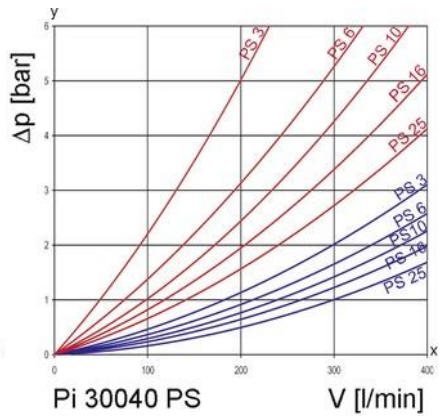
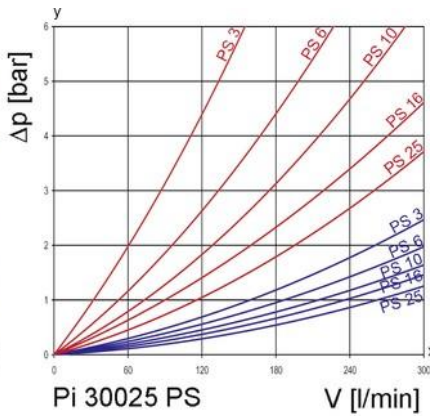
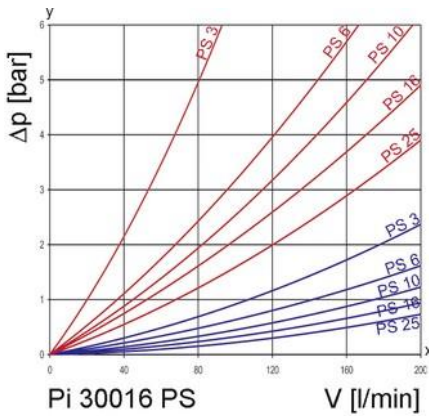
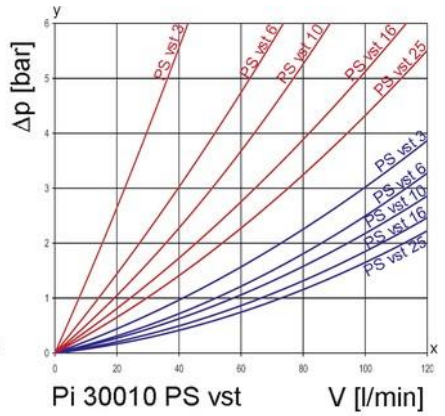
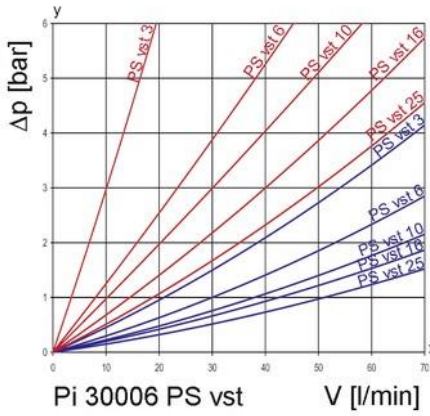
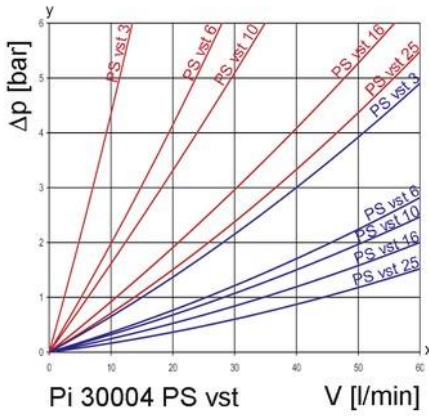
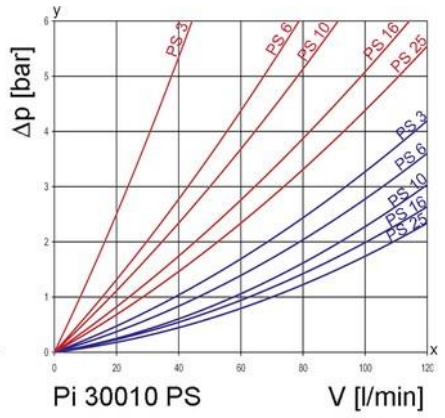
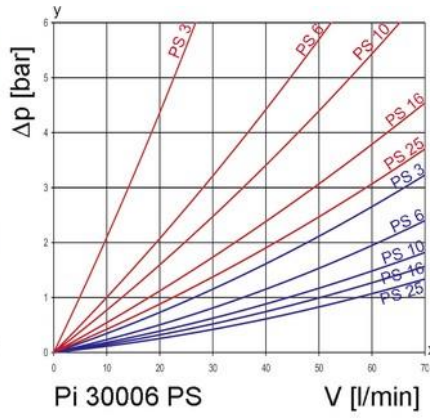
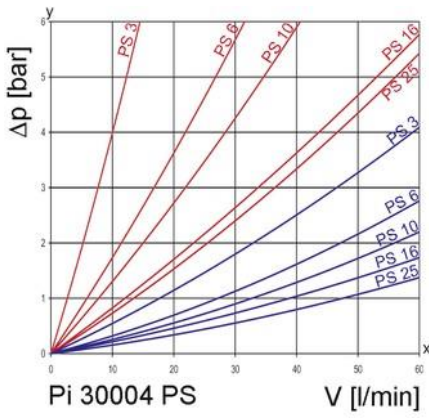

y = differential pressure Δp [bar]
x = flow rate V [l/min]

3. Separation grade characteristics

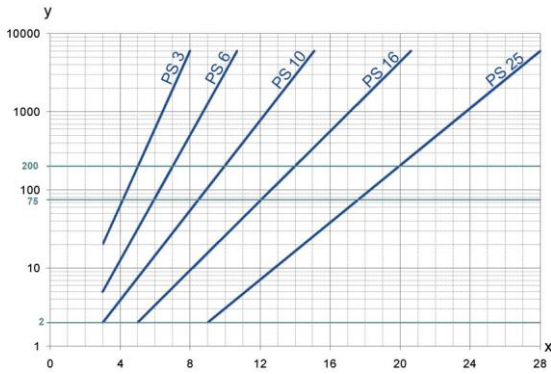

y = beta-value
x = particle size [μm]

determined by multipass tests (ISO 16889)
calibration according to ISO 11171 (NIST)

4. Filter performance data

tested according to ISO 16889 (multipass test)

PS elements with
max. Δp 20 bar

PS	3	$\beta_{5(C)} \geq 200$
PS	6	$\beta_{7(C)} \geq 200$
PS	10	$\beta_{10(C)} \geq 200$
PS	16	$\beta_{15(C)} \geq 200$
PS	25	$\beta_{20(C)} \geq 200$

values guaranteed up to
10 bar differential pressure

PS vst elements with
max. Δp 210 bar

PS vst	3	$\beta_{5(C)} \geq 200$
PS vst	6	$\beta_{7(C)} \geq 200$
PS vst	10	$\beta_{10(C)} \geq 200$
PS vst	16	$\beta_{15(C)} \geq 200$
PS vst	25	$\beta_{20(C)} \geq 200$

values guaranteed up to
20 bar differential pressure

5. Quality assurance

Filtration Group filters and filter elements are produced according to the following international standards:

Norm	Designation
DIN ISO 2941	Hydraulic fluid power filter elements; verification of collapse/burst resistance
DIN ISO 2942	Hydraulic fluid power filter elements; verification of fabrication integrity
DIN ISO 2943	Hydraulic fluid power filter elements; verification of material compatibility with fluids
DIN ISO 3723	Hydraulic fluid power filter elements; method for end load test
DIN ISO 3724	Hydraulic fluid power filter elements; verification of flow fatigue characteristics
ISO 3968	Hydraulic fluid power filters; evaluation of pressure drop versus flow characteristics
ISO 10771.1	Fatigue pressure testing of metal containing envelopes in hydraulic fluid applications
ISO 16889	Hydraulic fluid power filters; multipass method for evaluation filtration performance of a filter element

6. Symbols

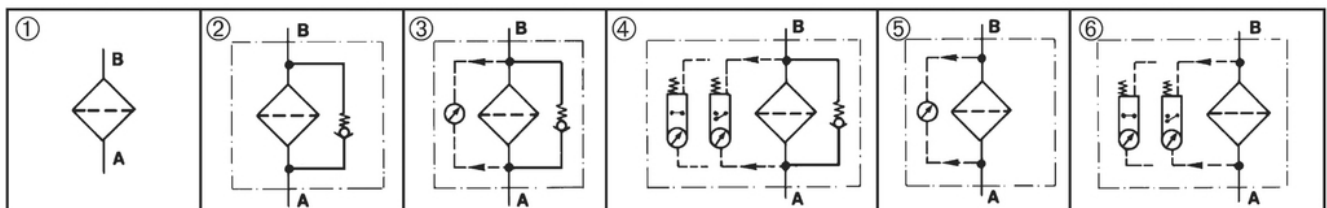

7. Order numbers

Example for ordering filters:

1. Filter housing	2. Filter element
V = 100l/min and electrical maintenance indicator Type: Pi 30010-015 Order number: 78208084	PS vst 3 Type: Pi 71010 DN PS vst 3 Order number: 78227480

Nominal size NG [l/min]	Order number	Type	①	②	③	④	⑤	⑥
			with indicator cavity	with bypass valve and indicator cavity	with bypass valve and visual indicator	with bypass valve and electrical indicator	with visual indicator	with electrical indicator
40	78207896	Pi 30004-010						
	78207904	Pi 30004-011						
	78337388	Pi 30004-012						
	78304206	Pi 30004-013						
	78207938	Pi 30004-014						
	78207946	Pi 30004-015						
63	78207961	Pi 30006-010						
	78207979	Pi 30006-011						
	78207987	Pi 30006-012						
	78304214	Pi 30006-013						
	78208001	Pi 30006-014						
	78208019	Pi 30006-015						
100	78208035	Pi 30010-010						
	78208043	Pi 30010-011						
	78208050	Pi 30010-012						
	78304222	Pi 30010-013						
	78208076	Pi 30010-014						
	78208084	Pi 30010-015						
160	78208100	Pi 30016-010						
	78208118	Pi 30016-011						
	78208126	Pi 30016-012						
	78259970	Pi 30016-013						
	78208142	Pi 30016-014						
	78208159	Pi 30016-015						
250	78208167	Pi 30025-010						
	78208175	Pi 30025-011						
	78208183	Pi 30025-012						
	78259988	Pi 30025-013						
	78208209	Pi 30025-014						
	78208217	Pi 30025-015						
400	78208225	Pi 30040-010						
	78208233	Pi 30040-011						
	78208241	Pi 30040-012						
	78259996	Pi 30040-013						
	78208266	Pi 30040-014						
	78208274	Pi 30040-015						

When filter with non bypass configuration is selected, the collapse pressure of the element must not be exceeded.

7.2 Filter elements*

Nominal size NG [l/min]	Order number	Type	Filter material	max. Δp [bar]	Filter surface [cm ²]
40	78260929	Pi 21004 DN PS 3 NBR	PS 3	20	475
	77960859	Pi 22004 DN PS 6 NBR	PS 6		475
	77925571	Pi 23004 DN PS 10 NBR	PS 10		475
	78260937	Pi 24004 DN PS 16 NBR	PS 16		475
	78260945	Pi 25004 DN PS 25 NBR	PS 25		475
	78216079	Pi 71004 DN PS vst 3 NBR	PS vst 3	210	445
	77960156	Pi 72004 DN PS vst 6 NBR	PS vst 6		445
	77925654	Pi 73004 DN PS vst 10 NBR	PS vst 10		445
	78216087	Pi 74004 DN PS vst 16 NBR	PS vst 16		445
	78216095	Pi 75004 DN PS vst 25 NBR	PS vst 25		445
63	78260960	Pi 21006 DN PS 3 NBR	PS 3	20	835
	77960867	Pi 22006 DN PS 6 NBR	PS 6		835
	77925589	Pi 23006 DN PS 10 NBR	PS 10		835
	78260978	Pi 24006 DN PS 16 NBR	PS 16		835
	78260986	Pi 25006 DN PS 25 NBR	PS 25		835
	78216137	Pi 71006 DN PS vst 3 NBR	PS vst 3	210	780
	77960149	Pi 72006 DN PS vst 6 NBR	PS vst 6		780
	77925662	Pi 73006 DN PS vst 10 NBR	PS vst 10		780
	78216145	Pi 74006 DN PS vst 16 NBR	PS vst 16		780
	78216152	Pi 75006 DN PS vst 25 NBR	PS vst 25		780
100	78227472	Pi 21010 DN PS 3 NBR	PS 3	20	1375
	77960875	Pi 22010 DN PS 6 NBR	PS 6		1375
	77925597	Pi 23010 DN PS 10 NBR	PS 10		1375
	78261000	Pi 24010 DN PS 16 NBR	PS 16		1375
	78261018	Pi 25010 DN PS 25 NBR	PS 25		1375
	78227480	Pi 71010 DN PS vst 3 NBR	PS vst 3	210	1275
	77960131	Pi 72010 DN PS vst 6 NBR	PS vst 6		1275
	77925670	Pi 73010 DN PS vst 10 NBR	PS vst 10		1275
	78261281	Pi 74010 DN PS vst 16 NBR	PS vst 16		1275
	78216160	Pi 75010 DN PS vst 25 NBR	PS vst 25		1275

* a wider range of element types is available on request

7.2 Filter elements*

Nominal size NG [l/min]	Order number	Type	Filter material	max. Δp [bar]	Filter surface [cm ²]
160	78261034	Pi 21016 DN PS 3 NBR	PS 3	20	2530
	77960826	Pi 22016 DN PS 6 NBR	PS 6		2530
	77925605	Pi 23016 DN PS 10 NBR	PS 10		2530
	78261042	Pi 24016 DN PS 16 NBR	PS 16		2530
	78261059	Pi 25016 DN PS 25 NBR	PS 25		2530
	77940638	Pi 71016 DN PS vst 3 NBR	PS vst 3	210	1885
	77960123	Pi 72016 DN PS vst 6 NBR	PS vst 6		1885
	77925688	Pi 73016 DN PS vst 10 NBR	PS vst 10		1885
	78269797	Pi 74016 DN PS vst 16 NBR	PS vst 16		1885
	78216178	Pi 75016 DN PS vst 25 NBR	PS vst 25		1885
250	78227514	Pi 21025 DN PS 3 NBR	PS 3	20	4020
	77960834	Pi 22025 DN PS 6 NBR	PS 6		4020
	77925613	Pi 23025 DN PS 10 NBR	PS 10		4020
	78261075	Pi 24025 DN PS 16 NBR	PS 16		4020
	78261083	Pi 25025 DN PS 25 NBR	PS 25		4020
	77940646	Pi 71025 DN PS vst 3 NBR	PS vst 3	210	3090
	77960115	Pi 72025 DN PS vst 6 NBR	PS vst 6		3090
	77925696	Pi 73025 DN PS vst 10 NBR	PS vst 10		3090
	78269813	Pi 74025 DN PS vst 16 NBR	PS vst 16		3090
	78216186	Pi 75025 DN PS vst 25 NBR	PS vst 25		3090
400	78227522	Pi 21040 DN PS 3 NBR	PS 3	20	6770
	77960842	Pi 22040 DN PS 6 NBR	PS 6		6770
	77925621	Pi 23040 DN PS 10 NBR	PS 10		6770
	78261109	Pi 24040 DN PS 16 NBR	PS 16		6770
	78261117	Pi 25040 DN PS 25 NBR	PS 25		6770
	77940653	Pi 71040 DN PS vst 3 NBR	PS vst 3	210	5240
	77960107	Pi 72040 DN PS vst 6 NBR	PS vst 6		5240
	77930829	Pi 73040 DN PS vst 10 NBR	PS vst 10		5240
	78269821	Pi 74040 DN PS vst 16 NBR	PS vst 16		5240
	78260903	Pi 75040 DN PS vst 25 NBR	PS vst 25		5240

* a wider range of element types is available on request

8. Technical specifications

Design:	in-line filter
Nominal pressure:	
Pi 30004 - 30010	315 bar (4570 psi)
Pi 30016 - 30040	200 bar (2900 psi)
Test pressure:	
Pi 30004 - 30010	410 bar (5940 psi)
Pi 30016 - 30040	260 bar (3770 psi)
Temperature range:	-10 °C to +120 °C (other temperature ranges on request)
Bypass setting:	Δp 7 bar \pm 10 %
Filter head material:	GGG
Filter housing material:	St
Sealing material:	NBR/PTFE
Maintenance indicator setting:	Δp 5 bar \pm 10 %
Electrical data of maintenance indicator:	
Maximum voltage:	250 V AC/200 V DC
Maximum current:	1 A
Contact load:	70 W
Type of protection:	IP 65 in inserted and secured status
Contact:	normally open/closed
Cable sleeve:	M20x1.5

The switching function can be changed by turning the electric upper part by 180° (normally closed contact or normally open contact). The state on delivery is a normally closed contact. By inductivity in the direct current circuit the use of suitable protection circuit should be considered. Further maintenance indicator details and designs are available in the maintenance indicator data sheet.

We draw attention to the fact that all values indicated are average values which do not always occur in specific cases of application. Our products are continually being further developed. Values, dimensions and weights can change as a result of this. Our specialized department will be pleased to offer you advice.

We recommend you to contact us concerning applications of our filters in areas governed by the EU Directive 94/9 EC (ATEX 95). The standard version can be used for liquids based on mineral oil (corresponding to the fluids in Group 2 of Directive 97/23 EC Article 9). If you consider to use other fluids please contact us for additional support.

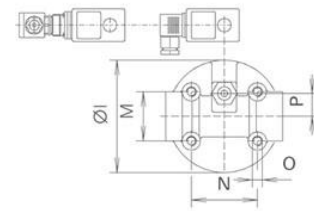
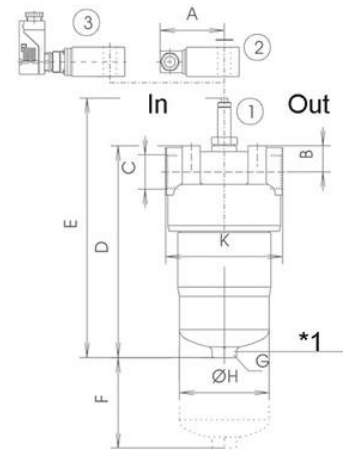

NG 160 - 400

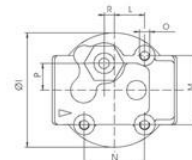

NG 40 - 100

In = inlet

Out = outlet

*1 NG 250, 400 with drain screw G ¼ DIN 910

- Pos. 1 Visual maintenance indicator
- Pos. 2 Electrical upper section connector according DIN EN 175301-803
Version: PiS 3092, 3105, 3115
- Pos. 3 Electrical upper section connector according DIN EN 175301-804
Version: PiS 3102, 3122, 3132

Subject to technical alteration without prior notice.

9. Dimensions

All dimensions except "C" in mm.

Type	A	B	C*	D	E	F	G SW	H	I	K	L	M	N	O	P	R	Weight [kg]
Pi 30004	78	31	G½	181	238	80	27	66	90	92	23.5	54	47	M8x16	21	8	4.2
Pi 30006	78	31	G¾	241	298	80	27	66	90	92	23.5	54	47	M8x16	21	8	4.9
Pi 30010	78	31	G1	331	389	80	27	66	90	92	23.5	54	47	M8x16	21	8	5.8
Pi 30016	78	32	G1¼	267	324	110	30	109	137	142	-	60	80	M12x16	28	-	10.0
Pi 30025	78	32	G1¼	357	414	110	30	109	137	142	-	60	80	M12x16	28	-	12.0
Pi 30040	78	32	G1¼	507	564	110	30	109	137	142	-	60	80	M12x16	28	-	15.6

* NPT- and SAE- port connections on request

10. Installation, operating and maintenance instructions

10.1 Filter installation

When installing the filter make sure that sufficient space is available to remove filter element and filter housing! Preferably the filter should be installed with the filter housing pointing downwards.

The maintenance indicator must be visible.

10.2 Connecting the electrical maintenance indicator

The electrical indicator is connected via a 2-pole appliance plug according to DIN EN 175301-803 with poles marked 1 and 2.

The electrical section can be inverted to change from normally open position to normally closed position or vice versa.

10.3 When should the filter element be replaced?

- Filters equipped with visual and electrical maintenance indicator:
During cold starts, the indicator may give a warning signal. Press the red button of the visual indicator once again only after operating temperature has been reached. If the red button immediately pops up again and/or the electrical signal has not switched off after reaching operating temperature, the filter element must be replaced after the end of the shift.
- Filters without maintenance indicator:
The filter element should be replaced after the trial run or flushing of the system. Afterwards follow instructions of the manufacturer.
- Please always ensure that you have Original Filtration Group spare elements in stock: Disposable elements (PS) cannot be cleaned.

10.4 Element replacement

- Stop system and relieve filter from pressure.
- Filter sizes 250 and 400: empty the filter housing by removing the drain plug.
- Unscrew the filter housing by turning counter-clockwise. Clean the housing using a suitable cleaning solvent.
- Remove element by pulling down carefully.
- Check o-ring and spigot for damage. Replace, if necessary.
- Make sure that the order number on the spare element corresponds to the order number of the filter name-plate. To ensure no contamination occurs during the exchange of the element first open the plastic bag and push the element over the spigot in the filter head. Now remove plastic bag.
- Lightly lubricate threads of the filter housing a little bit and screw into the filter head. Maximum tightening torque for NG 40 to 100 = 60 Nm, for NG 160 to 400 = 100 Nm.
- Check seals of vent drain plug - if necessary, please replace. Torque drain plug 30 Nm.

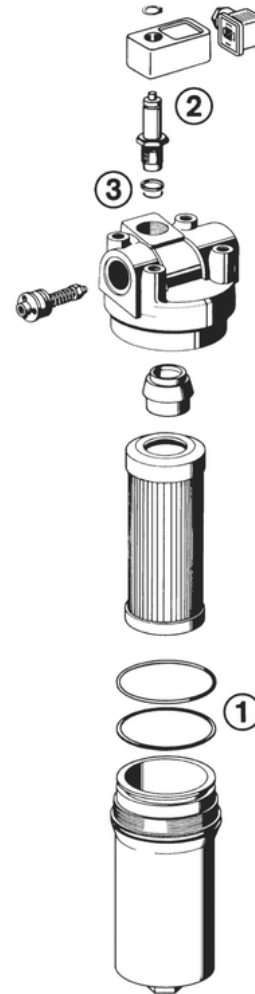

11. Spare parts list

Order numbers for spare parts		
Position	Type	Order number
①	Seal kit for filter	
	Pi 30004 - Pi 30010	
	NBR	78383747
	FPM	78383754
	EPDM	78383762
	Pi 30016 - Pi 30040	
	NBR	78383770
	FPM	78383788
	EPDM	78383796
②	Maintenance indicator	
	Visual PiS 3093/5	77669914
	Electrical PiS 3092/5	77669864
	Electrical upper section only	77536550
③	Seal kit for maintenance indicator	
	NBR	77760275
	FPM	77760283
	EPDM	77760291

Filtration Group GmbH
Schleifbachweg 45
D-74613 Öhringen
Phone +49 7941 6466-0
Fax +49 7941 6466-429
fm.de.sales@filtrationgroup.com
www.fluid.filtrationgroup.com
78396012.06/2019