

Filter elements

3-stage filter elements for lubricating oil filtration

Resistant to differential pressure up to 30 bar, nominal size 100 to 300 l/min

1. Features

3-stage filter element for lubricating systems

The Filtration Group 3-stage filter element with the unique Premium Select element structure, reliable integrated bypass valves and the sturdy safety insert is used for gearbox oil filtration in wind turbines. These filter elements are used in the oil filter modules Pi 831x and the low-pressure filters Pi 260.

- Filter elements with three filtration stages for the filtration of lubricating oil in wind turbine gearboxes.
- Unique, multilayer Filtration Group Premium Select (PS) folding star-shape filter design made of chemically and thermally resistant materials.
- Filter performance that fits like a glove: A force-fit fixing fleece material, the so called **PulseShield™ Pro**, presses the folding star-shape tight to the supporting body and fixes the folds in place in such a way as to prevent block formation. The fixing fleece takes over a pre-filter function at the same time.
- Progressive structure: The degree of fineness of the glass fibre material decreases from the inside to the outside, combining the advantages of a depth filter with those of a large effective filtering surface. The result: greater dirt pick-up capacity even at lower pressure loss in conjunction with a defined discharging rate (multipass test in compliance with ISO 16889).
- Supporting fibre on both sides made of high-quality stainless steel ensures the high rigidity of the folding star-shape.
- Chemical resistance is guaranteed by the use of high-grade stainless steel wire mesh.
- Supporting body and end plates are made of materials free of chromium VI.
- Suitable for universal use for hydraulic and lubricating fluids, fuels, aqueous media and synthetic fluids.
- Low initial differential pressure
- Version for Filtration Group filter housing as alternative elements in the dimensions of other manufacturers and in customer-specific designs.
- High differential pressure stability and dirt pick-up capacity of the elements
- Worldwide distribution



2. Quality assurance

Filtration Group filters and filter elements are manufactured and/or tested in compliance with the following international standards:

Standard	Designation
DIN ISO 2941	Hydraulic fluid power filter elements; verification of collapse/burst resistance
DIN ISO 2942	Hydraulic fluid power filter elements; verification of fabrication integrity
DIN ISO 2943	Hydraulic fluid power filter elements; verification of material compatibility with fluids
DIN ISO 3723	Hydraulic fluid power filter elements; method for end load test
DIN ISO 3724	Hydraulic fluid power filter elements; verification of flow fatigue characteristics
ISO 3968	Hydraulic fluid power-filters-evaluation of pressure drop versus flow characteristics
ISO 10771.1	Fatigue pressure testing of metal containing envelopes in hydraulic fluid applications
ISO 16889	Hydraulic fluid power filters-multipass method for evaluating filtration performance of a filter element

3. Functional description

The filter element is the central component in which the filtration process takes place.

The 3-stage filter elements used for lubricating oil filtration in wind turbines are a combination of depth filters (1st and 2nd filter stage) and a surface filter (3rd filter stage – wire mesh).

The upper end plate (4) contains the bypass valves (explanation, see bypass mode) and fixing tabs that are tailored to the filter cover so that the filter element is always in the center of the housing and does not touch the inside of the filter housing. This ensures that the same hydraulic cross-section is always available to ensure constant filtration.

The first filter stage (1) is the WS PS 3 filter stage (water adsorber integrated in the Premium Select folding star-shape, filter fineness 3 µm). Water is also taken in during this filter stage to absorb the dirt and separate oil ageing products. The second filter stage (2) is the PS 10 filter stage (Premium Select, filter fineness 10 µm).

The intermediate plate (6) connects the first filter stage (WS PS 3) and the second filter stage (PS 10) and is designed with a spacer (7) so that the filter element does not rest on the inner wall of the filter housing when the filter cover is loosened to replace the element. This makes it easy to handle and change the filter element when replacing the element.

The spacer is reusable and therefore not part of the replacement element delivery. The spacer have to be disassembled from the old soiled filter element and then be mounted on the new filter element.

The lower end plate (5) incl. the O-ring is used to mount the filter element in the filter head.

The direction of flow through the 3-stage filter element is from the outside to the inside. The filter stages 1 and 2, the multilayer star-pleated depth filter, are responsible for achieving the prescribed purity class. Inside the first filter stage (1), the protection filter (3), a wire mesh surface filter, is installed in such a way that only filtered oil is allowed to flow into the gearbox at all times.

There are 2 operating modes, standard mode and bypass mode

Standard mode:

The bypass valves in the upper end plate (4) are closed so that the unfiltered oil flows through the 1st and 2nd filter stage (1 and 2), the depth filters, at the same time.

Then the pre-filtered oil and the oil released from the water flows through the surface filter (3), the 3rd filter stage.

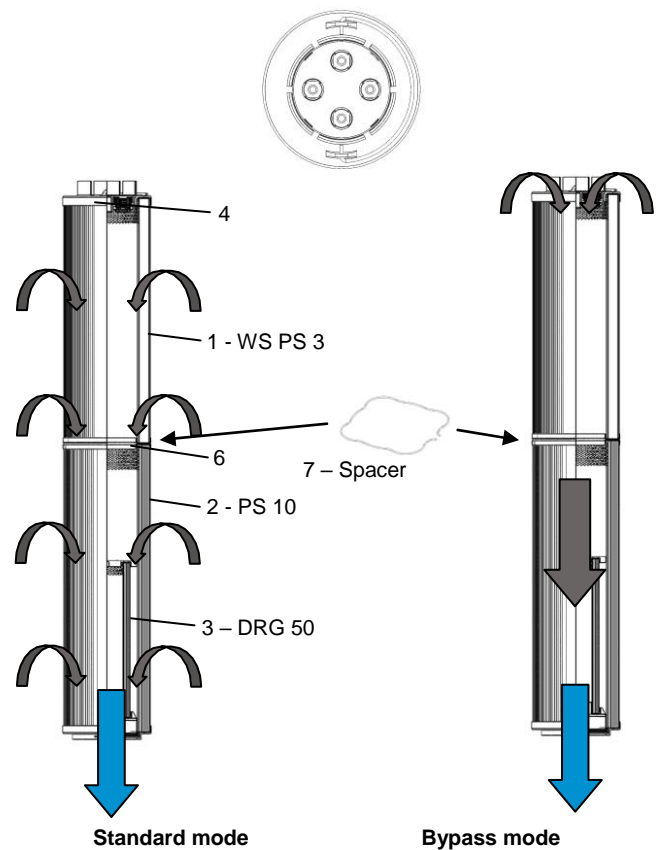
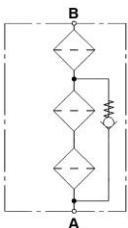

Bypass mode:

With a lubrication system cold start, the viscosity of the lubricating oil (ISO VG 320) can be so high that the pressure built up at the filter element is high enough to open the bypass valves integrated in the upper end plate (4). This means that part of the unfiltered oil flows past the filter stages (1 and 2) and gets into the inside of the 3-stage filter element unfiltered and where it flows through the third filter stage (3). This guarantees that the wind turbine gearbox is always supplied with filtered oil.

4. Filter media

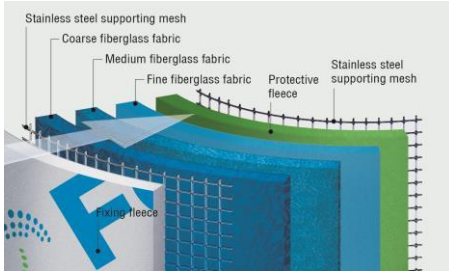

Structure of a PS folding star-shape

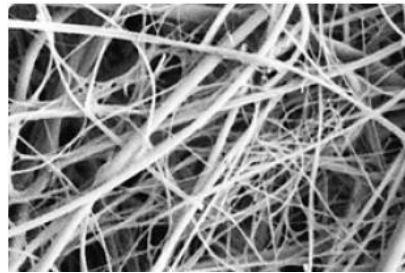

Micro-glass fibre

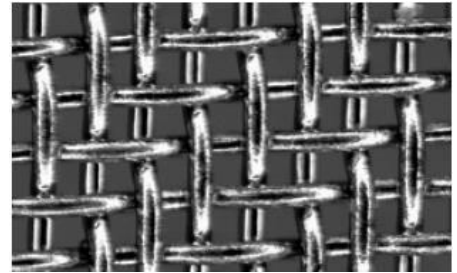

Wire mesh

4.1 Filter medium PS

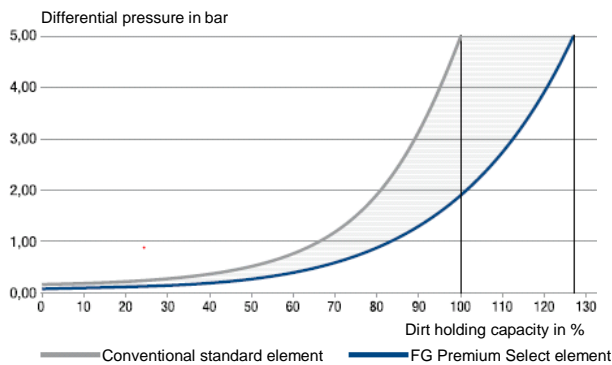

Higher performance in the long term plus a longer service life: Innovative Premium Select element with 30% more dirt pick-up capacity, lower differential pressure and optimised differential pressure distribution – for reduced energy consumption.
 Höhere Leistung im Langzeitbetrieb plus eine längere Lebensdauer: Innovative Premium Select Element mit 30% mehr Verschmutzungskapazität, niedrigerem Differenzdruck und optimiertem Differenzdruckverlauf – für reduzierten Energieverbrauch.

There is a complete range of filter elements available for use in wind power applications. Filtration Group Premium Select elements reduce solid soiling to the prescribed soiling class and maintain the properties of the lubricating fluid over a long period.

Filtration Group Premium Select elements are tested to all the usual hydraulic standards. After all, we want results we can objectively prove to customers. For this reason, we only monitor our products against globally recognized standards such as ISO 16889. Here our filters achieve outstanding values in terms of their dirt holding capacity, beta-value stability and retaining rate.

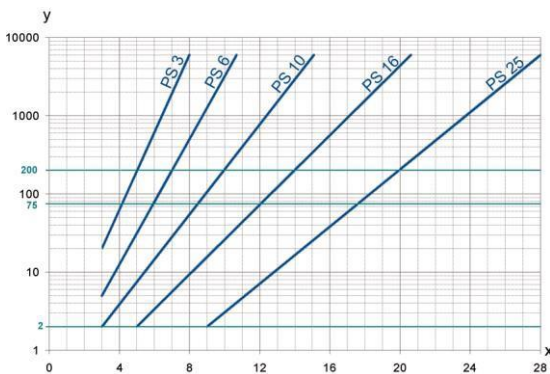

y = beta value
 x = particle size [µm]

determined by multipass tests (ISO 16889)
 Calibration in accordance with ISO 11171 (NIST)

The filters in a hydraulic or lubricating system have the task of controlling and maintaining the contamination of the fluid at the required level over a long period of time during operation. It is usual to use codes for the numbers of particles to mark solid impurities in industrial hydraulics in accordance with ISO 4406. The purity classes which can be achieved with PS filter elements are listed below. These values reflect our long years of experience in designing hydraulic filters and are to be viewed as reference values.

Purity classes	
Filter media	Purity classes in accordance with ISO 4406 (1999), > 4 µm(c)/ > 6 µm (c)/ >14 µm (c)
PS 3	14/12/09
PS 6	16/13/10
PS 10	17/15/11
PS 16	20/17/12
PS 25	23/19/13

Tested in accordance with ISO 16889 (multipass test)

PS elements with max. Δp 10 bar

PS	3 β _{5(C)}	≥ 200
PS	6 β _{7(C)}	≥ 200
PS	10 β _{10(C)}	≥ 200
PS	25 β _{20(C)}	≥ 200

up to 10 bar differential pressure

4.2 Filter material Drg

The filter element of the 3rd filter stage is made of stainless steel wire mesh and has very low flow resistance properties. The common fineness in the filtration of gearbox oil in wind turbines is 40 µm (type of weave: Twill weave) and 50 µm (type of weave: single braid). In the case of wire mesh elements the filter fineness is the diameter of the largest spherical particle that can just about pass through the mesh. Wire mesh elements are used in hydraulic and lubricating oil filtration as suction filters or coarse filters, with high-viscosity media as well as in safety filters in cooling lubricant filtration. Wire mesh elements have a sharp cut point as surface filters and a lower dirt pick-up capacity than depth filters.

5. Designation, ordering example and order numbers

5.1 Ordering example					
Type	Series				
852 273	Filter media 1st stage WS PS 3	Premium Select, fineness 10 µm	Filter media 2nd stage PS 10	Water adsorber integrated in the Premium Select folding star-shape, fineness 3µm	Filter media 3rd stage DRG 50
				Wire mesh, fineness 50 µm	Bypass valve V5.0
					Setting 5 bar
852 273	WS PS 3/	PS 10/	DRG 50/	V5.0	Ordering example

5.2 Order numbers for 2-stage elements for housing/oil filter modules from competitors						
Oil filter module	Designation	Element order no.	Spacer order no.		Filter area [cm²]	Dirt pick-up capacity * [g]
852 273	852 273 WS PS 3/PS 10/DRG 50/V5.0	72453688	72460354	WS PS 3	16.691	260
				PS 10	21.769	500
				DRG 50	2.655	-

Customer-specific version on request

6. Technical data

Folding star-shape	Pleated (star-pleated)
Direction of flow	from the outside to the inside
End plates and supporting tubes	Free of chromium VI
Resistance to collapse	30 bar
Operating temperature range	-10°C to +120°C
Seals	NBR (other materials on request)
Adhesive	Epoxy resin